

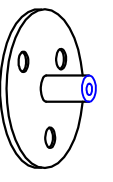









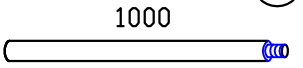
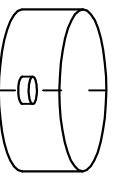
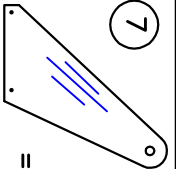
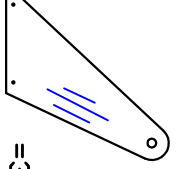
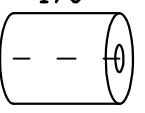
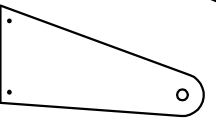
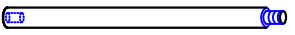

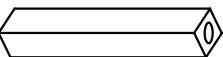
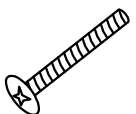
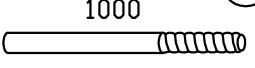

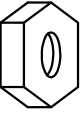
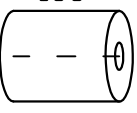
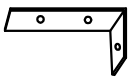

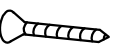
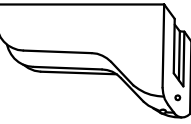
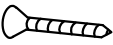
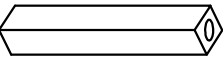
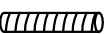
1		2		3	 6x80 mm	4		5	 1000	6		7	 =4  =3	8	 170	9	
	=16		=1		=3		=1		=1		=1		=4		=14		=7
10		11		12		13	 M8x50mm	14	 1000	15		16	 M16	17	 165	18	
	=1		=1		=15		=28		=1		=1		=1		=6		
19	 5x25 mm	20	 5x50 mm	21		22	 4x40 mm	23		24	 M8x70mm						
	=6		=12		=6		=6		=1		=1						

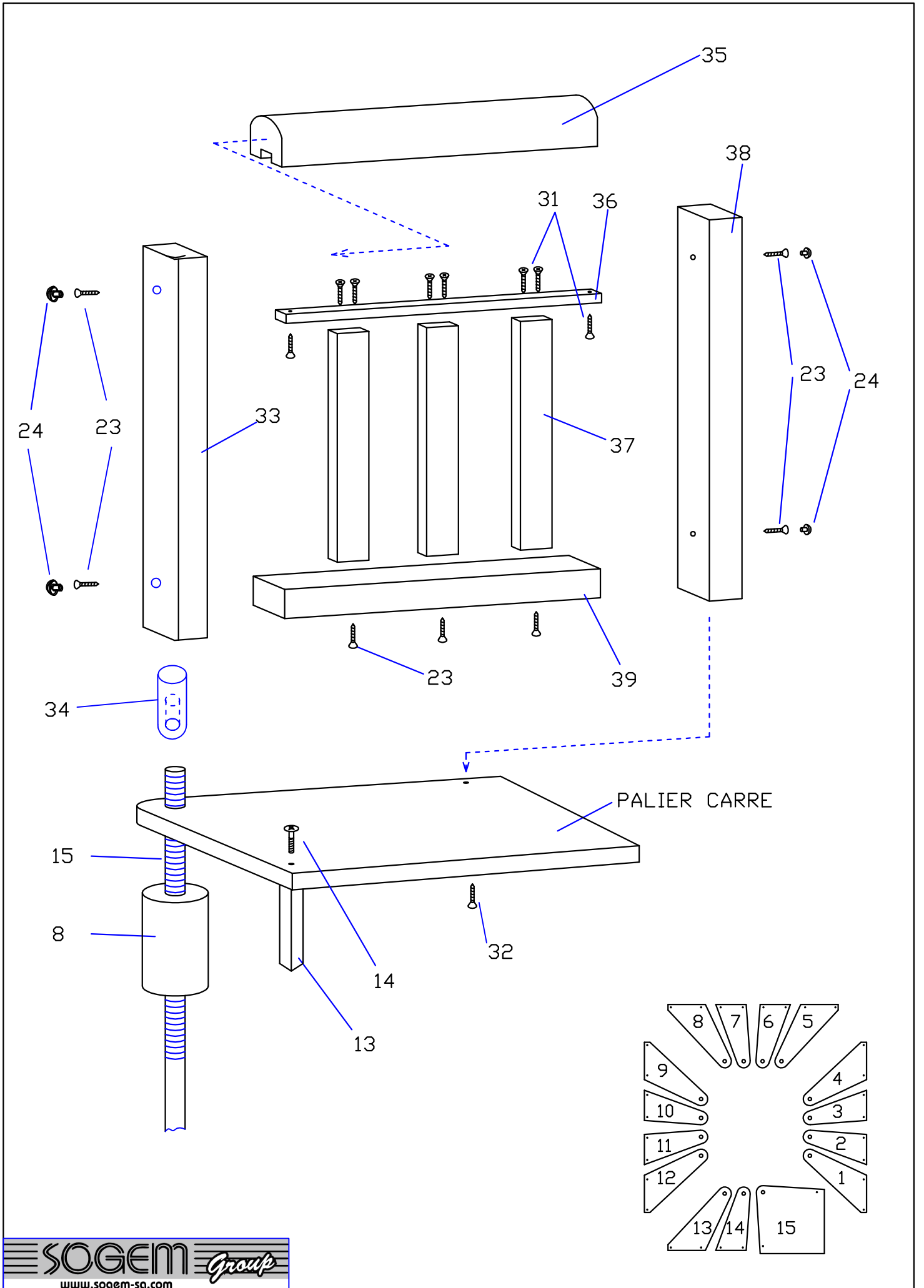
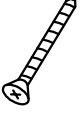
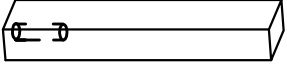
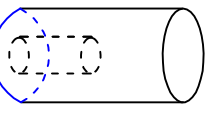
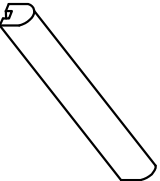
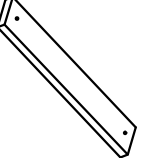
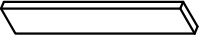
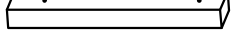
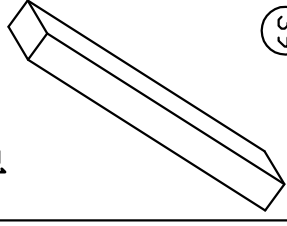

<p>(23)</p>  <p>5x60mm</p> <p>=7</p>	<p>(24)</p>  <p>=4</p>	<p>(31)</p>  <p>4x40mm</p> <p>=8</p>	<p>(32)</p>  <p>6x90</p> <p>=1</p>	<p>(33)</p>  <p>=1</p>	<p>(34)</p>  <p>=1</p>	<p>(35)</p>  <p>=1</p>	<p>(36)</p>  <p>=1</p>	<p>(37)</p>  <p>=3</p>
<p>(38)</p>  <p>=1</p>	<p>(39)</p>  <p>=1</p>							